

GV 407

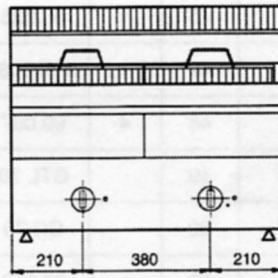

GV 807

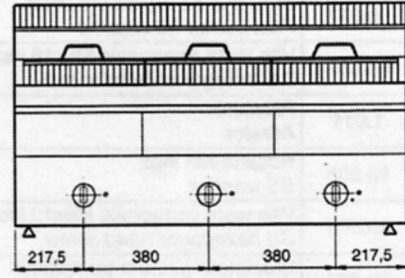

GV 1207

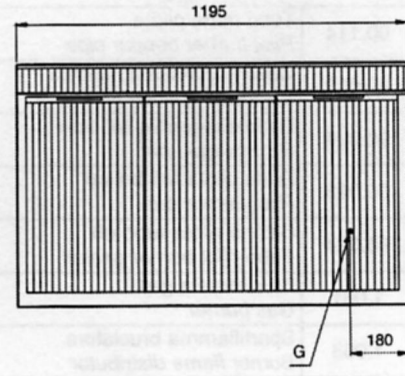
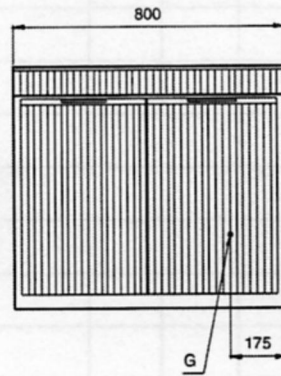
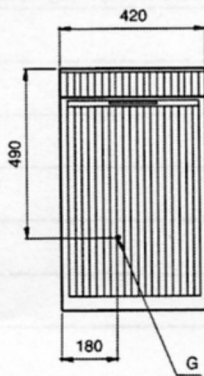

G = 3/4 UNI-ISO 7/1 Entrata gas
Gas inlet

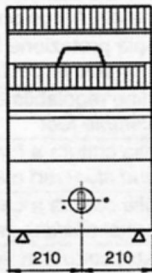
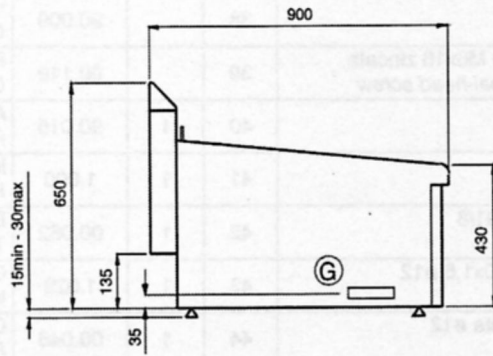

GV 409

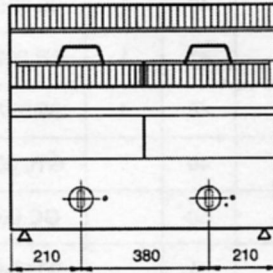

GV 809

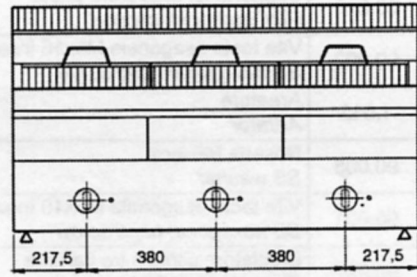

GV 1209

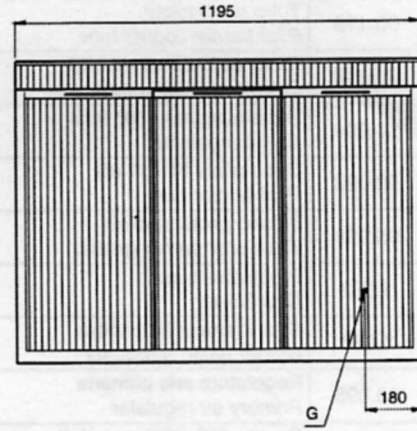
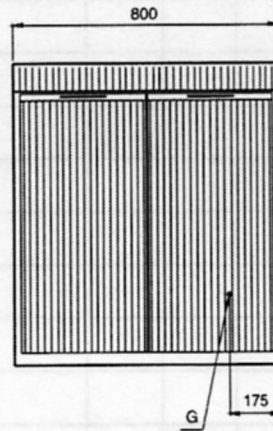
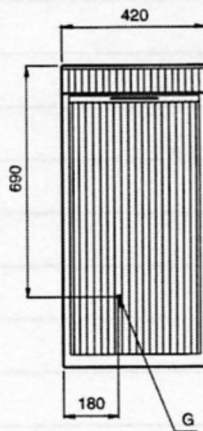

G = 3/4 UNI-ISO 7/1 Entrada gas
Gas inlet

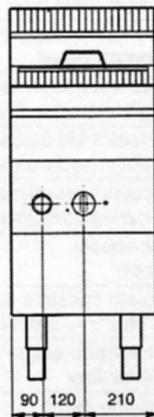
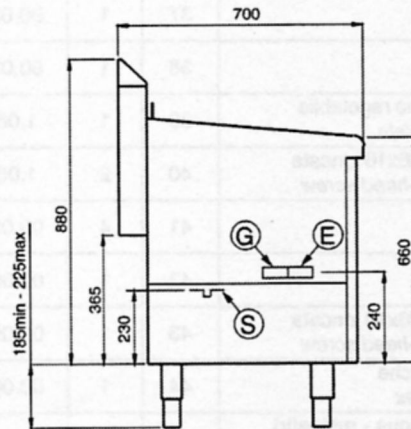

GV 417

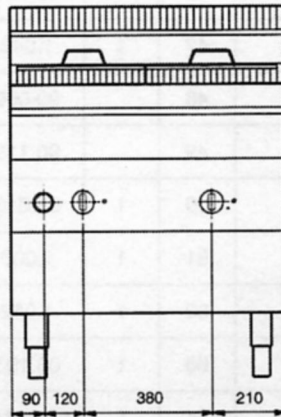

GV 817

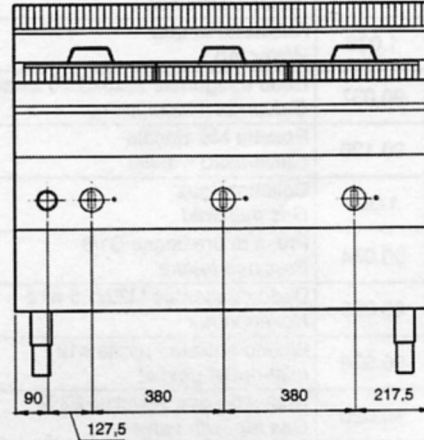

GV 1217

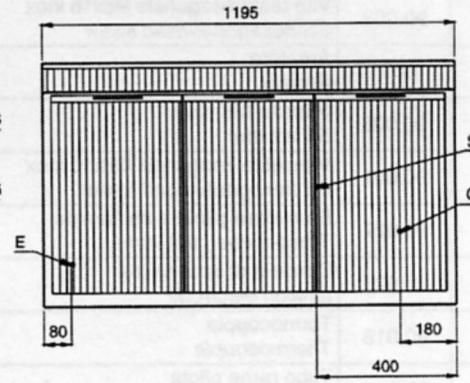
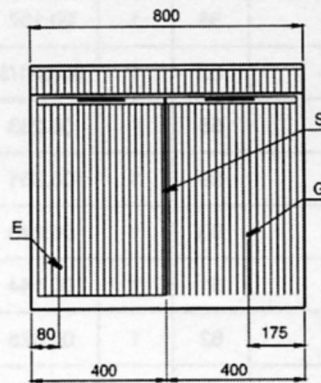
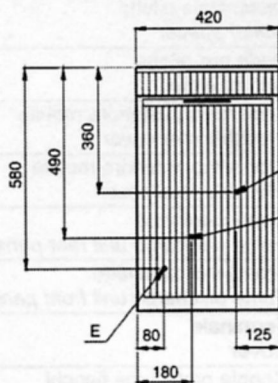

E = 1/2 Entrata acqua
Water inlet

G = 3/4 UNI-ISO 7/1 Entrata gas
Gas inlet

S = 1 1/4 Scarico acqua
Water outle



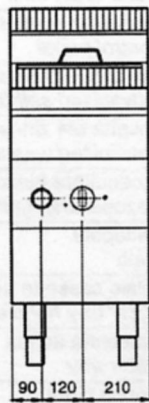
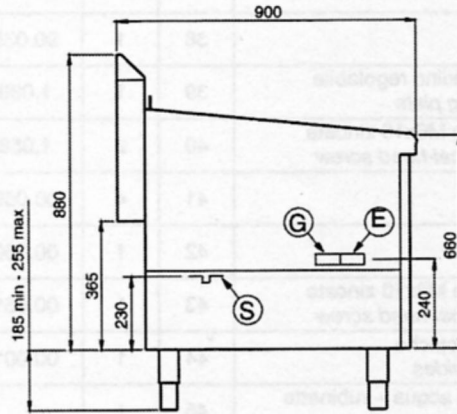

GV 419

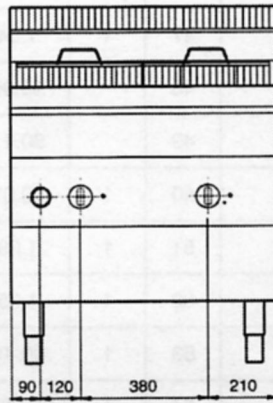

GV 819

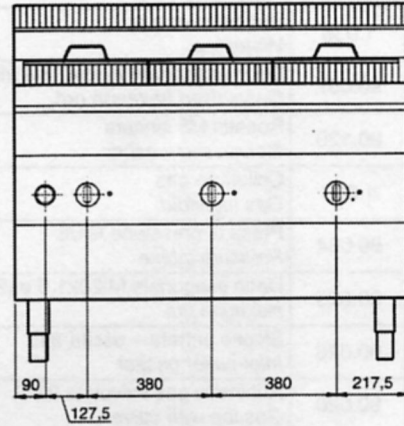

GV 1219

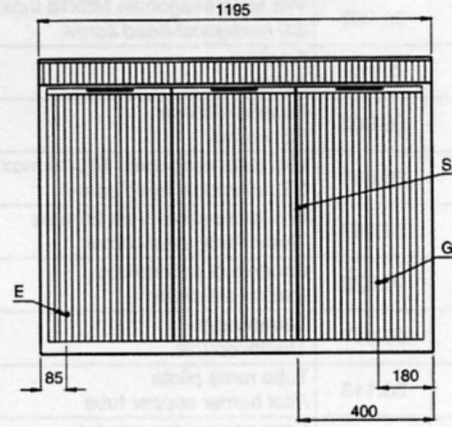
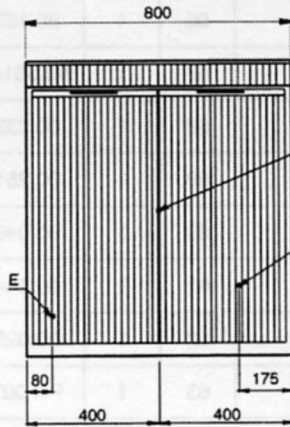
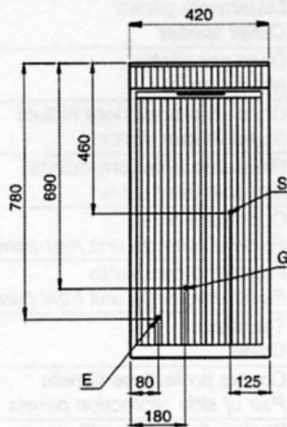

E = 1/2 Entrata acqua
Water inlet

G = 3/4 UNI-ISO 7/1 Entrata gas
Gas inlet

S = 1 1/4 Scarico acqua
Water outle

