

# DROP-IN - Elegance

	Dimensioni LxPxH	Codice	Modello
	Dimensions Abmessungen Dimensions	Code Kode Code	Model Modell Modelle
<b>SOVRASTRUTTURA CON VETRO DOPPIO</b>	785x460x400	8046185	ISVD2
Overshelf with double glass	1110x460x400	8046186	ISVD3
Aufsatzbord mit doppelt abgerundetem Glas	1440x460x400	8046187	ISVD4
Superstructure avec vitre double	1765x460x400	8046188	ISVD5
	2090x460x400	8046189	ISVD6

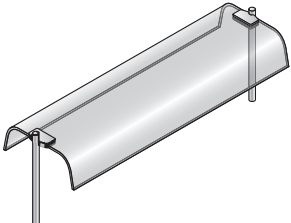

<b>SOVRASTRUTTURA CON VETRO SINGOLO</b>	785x360x400	8046250	ISVS2
Overshelf with single glass	1110x360x400	8046251	ISVS3
Aufsatzbord mit einseitig abgerundetem Glas	1440x360x400	8046252	ISVS4
Superstructure avec vitre single	1765x360x400	8046253	ISVS5
	2090x360x400	8046254	ISVS6

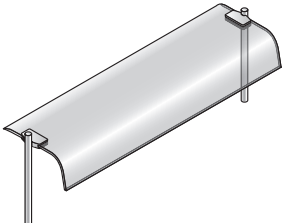

<b>VETRO FRONTALE TEMPRATO PER SOVRASTRUTTURA</b>	L = 805	8046155	IFS2
Front temperate crystal for overshelf	L = 1135	8046156	IFS3
Vorderes Kristall aus gehärtetem Glas für Aufsatzbord	L = 1455	8046157	IFS4
Cristal trempé frontal pour superstructure	L = 1780	8046158	IFS5
	L = 2105	8046159	IFS6

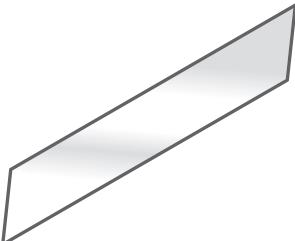

# DROP-IN - Elegance

	<b>Dimensioni LxPxH</b>	<b>Codice</b>	<b>Modello</b>
	Dimensions Abmessungen Dimensions	Code Kode Code	Model Modell Modelle
<b>ELEMENTO ILLUMINANTE PER SOVRASTRUTTURA - (LAMPADA NEON)</b> Lighting element for overshelf Beleuchtungselement (Neonlampe) für Aufsatzbord Élément éclairant (lampe au néon) pour superstructure	L = 805	8046190	ILS2
	L = 1135	8046191	ILS3
	L = 1455	8046192	ILS4
	L = 1780	8046193	ILS5
	L = 2105	8046225	ILS6

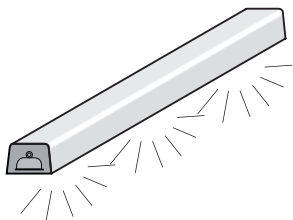

<b>ELEMENTO RISCALDANTE PER SOVRASTRUTTURA - (RESISTENZA)</b> Heating element (resistance) for overshelf Heizelement (Heizkorpus) für Aufsatzbord Élément chauffant (Résistance) pour superstructure	L = 805	8046194	IRS2
	L = 1135	8046195	IRS3
	L = 1455	8046196	IRS4
	L = 1780	8046197	IRS5
	L = 2105	8046227	IRS6

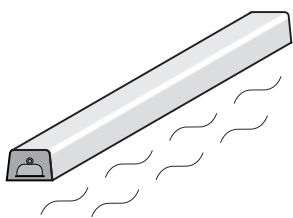

<b>COPERTURA MOBILE</b> Mobile cover Abnehmbare Deckung Superstructure mobile	795x625x560	8046557	I7CM2
	1120x625x560	8046558	I7CM3
	1450x625x560	8046559	I7CM4

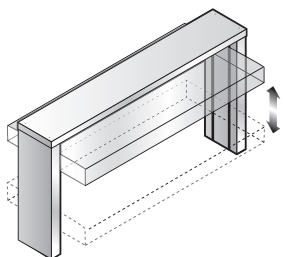

# DROP-IN - Elegance

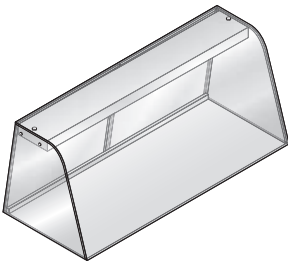
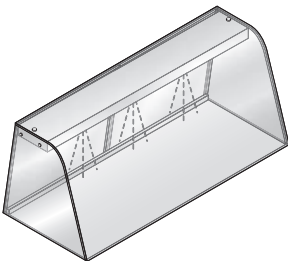
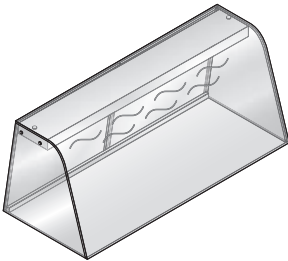
	<b>Dimensioni LxPxH</b>	<b>Codice</b>	<b>Modello</b>
	Dimensions Abmessungen Dimensions	Code Kode Code	Model Modell Modelle
<b>VETRINA NEUTRA CHIUSA CON PORTE SCORREVOLI</b> Neutral and closed display counter with sliding doors Geschlossene neutrale Vitrine mit Schiebetüren Vitrine neutre fermée avec portes coulissantes	762x684x460	8046540	I7VCN2
	1087x684x460	8046541	I7VCN3
	1440x684x460	8046542	I7VCN4
			
<b>VETRINA CON ELEMENTO ILLUMINANTE CHIUSA CON PORTE SCORREVOLI - (LAMPADA NEON)</b> Closed display counter with lightingelement and sliding doors Geschlossene neutrale Vitrine mit Schiebetüren, mit Beleuchtungselement (Neonlampe) Vitrine avec élément éclairant (lampe au néon) fermée avec portes coulissantes	762x684x460	8046545	I7VCL2
	1087x684x460	8046546	I7VCL3
	1440x684x460	8046547	I7VCL4
			
<b>VETRINA CON ELEMENTO RISCALDANTE CHIUSA CON PORTE SCORREVOLI - (RESISTENZA)</b> Closed display counter with heating element (resistance) and sliding doors Geschlossene neutrale Vitrine mit Schiebetüren, mit Heizelement (Heizkorpus) Vitrine avec élément chauffant (résistance) fermée avec portescoulissantes	762x684x460	8046549	I7VCR2
	1087x684x460	8046550	I7VCR3
	1440x684x460	8046551	I7VCR4
			
<b>VETRINA NEUTRA CHIUSA CON PORTINE BASCULANTI</b> Neutral display counter, closed with tilting doors Geschlossene neutrale Vitrine mit Schwingtüren Vitrine neutre fermée avec portes basculantes	775x630x420	8046561	I7VCPB2
	1100x630x420	8046562	I7VCPB3
	1430x630x420	8046563	I7VCPB4
	